



# SB20-03P

Schottky Barrier Diode

## 30V, 2A Rectifier

### Applications

- High frequency rectification (switching regulators, converters, choppers).

### Features

- Low forward voltage ( $V_F$  max=0.55V).
- Fast reverse recovery time ( $t_{rr}$  max=20ns).
- Low switching noise.
- Low leakage current and high reliability due to highly reliable planar structure.

### Package Dimensions

unit:mm

1163

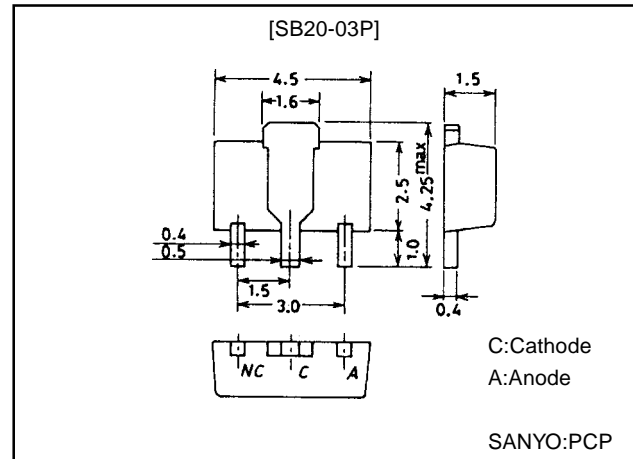

### Specifications

#### Absolute Maximum Ratings at $T_a = 25^\circ\text{C}$

Parameter	Symbol	Conditions	Ratings	Unit
Repetitive Peak Reverse Voltage	$V_{RRM}$		30	V
Nonrepetitive Peak Reverse Surge Voltage	$V_{RSM}$		35	V
Average Output Current	$I_O$		2	A
Surge Forward Current	$I_{FSM}$	50Hz sine wave, 1 cycle	20	A
Junction Temperature	$T_j$		-55 to +125	$^\circ\text{C}$
Storage Temperature	$T_{stg}$		-55 to +125	$^\circ\text{C}$

#### Electrical Characteristics at $T_a = 25^\circ\text{C}$

Parameter	Symbol	Conditions	Ratings			Unit
			min	typ	max	
Reverse Voltage	$V_R$	$I_R=500\mu\text{A}$	30			V
Forward Voltage	$V_F$	$I_F=2\text{A}$			0.55	V
Reverse Current	$I_R$	$V_R=15\text{V}$			100	$\mu\text{A}$
Interterminal Capacitance	C	$V_R=10\text{V}$ , $f=1\text{MHz}$		70		pF
Reverse Recovery Time	$t_{rr}$	$I_F=I_R=100\text{mA}$ , See specified Test Circuit			20	ns
Thermal Resistance (1)	Rthj-a (1)			300		$^\circ\text{C/W}$
Thermal Resistance (2)	Rthj-a (2)	Mounted on 250mm <sup>2</sup> ×0.8mm ceramic board		110		$^\circ\text{C/W}$

Marking:SC

#### $t_{rr}$ Test Circuit

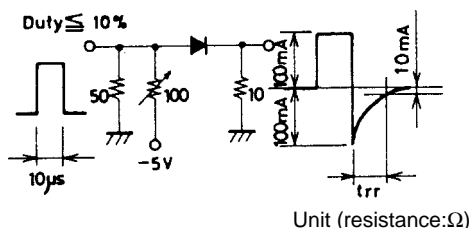

# SB20-03P

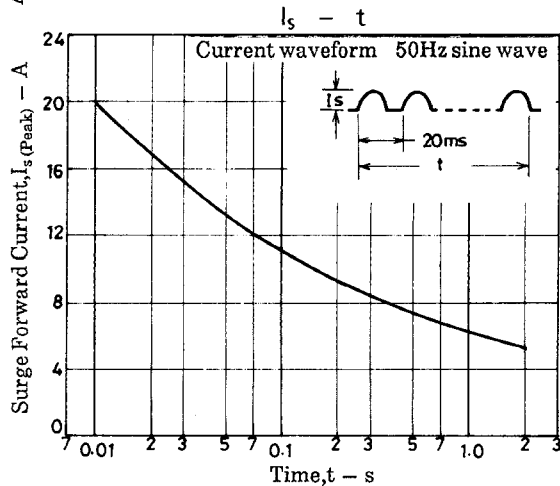
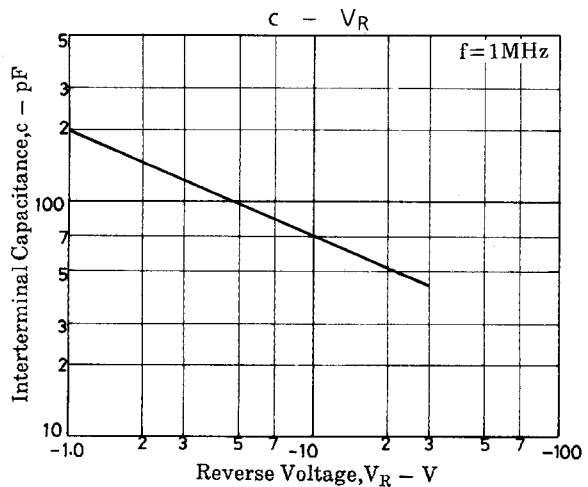
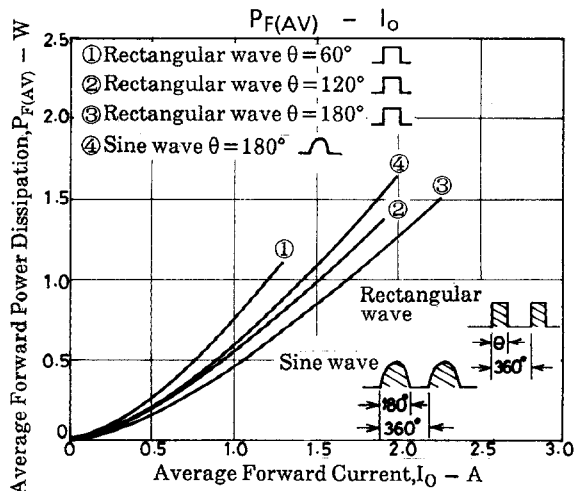
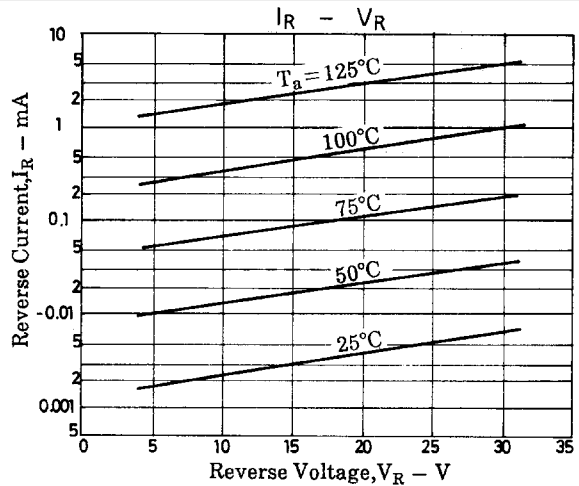
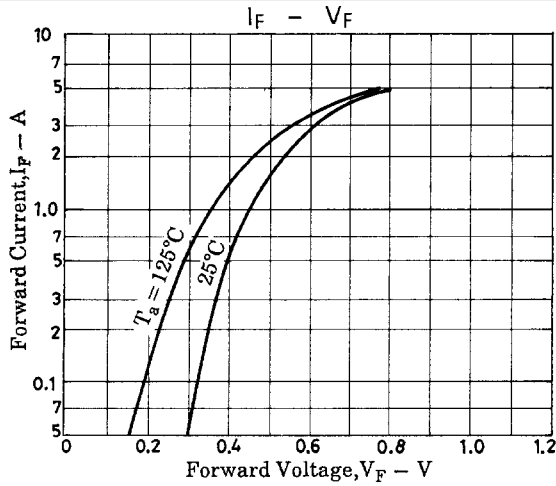

■ No products described or contained herein are intended for use in surgical implants, life-support systems, aerospace equipment, nuclear power control systems, vehicles, disaster/crime-prevention equipment and the like, the failure of which may directly or indirectly cause injury, death or property loss.

■ Anyone purchasing any products described or contained herein for an above-mentioned use shall:

- ① Accept full responsibility and indemnify and defend SANYO ELECTRIC CO., LTD., its affiliates, subsidiaries and distributors and all their officers and employees, jointly and severally, against any and all claims and litigation and all damages, cost and expenses associated with such use:
- ② Not impose any responsibility for any fault or negligence which may be cited in any such claim or litigation on SANYO ELECTRIC CO., LTD., its affiliates, subsidiaries and distributors or any of their officers and employees jointly or severally.

■ Information (including circuit diagrams and circuit parameters) herein is for example only; it is not guaranteed for volume production. SANYO believes information herein is accurate and reliable, but no guarantees are made or implied regarding its use or any infringements of intellectual property rights or other rights of third parties.

This catalog provides information as of May, 1998. Specifications and information herein are subject to change without notice.